

L  
O  
L  
A  
  
C  
A  
S  
T  
I  
L  
L  
O  
  
M  
O  
R  
A  
L  
E  
S

M  
I  
S  
T  
A  
N  
D

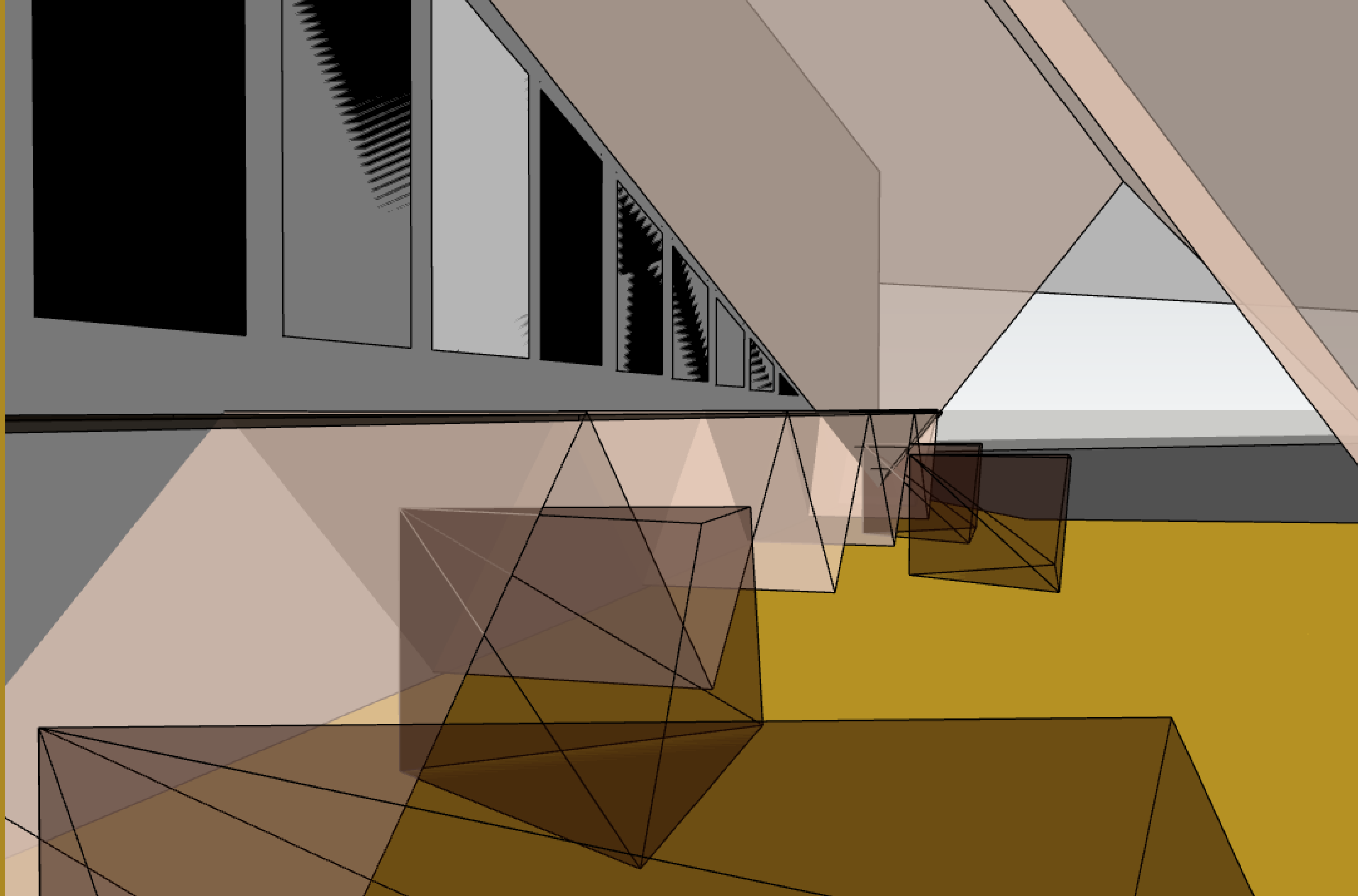

SITU  
ACION  
ON

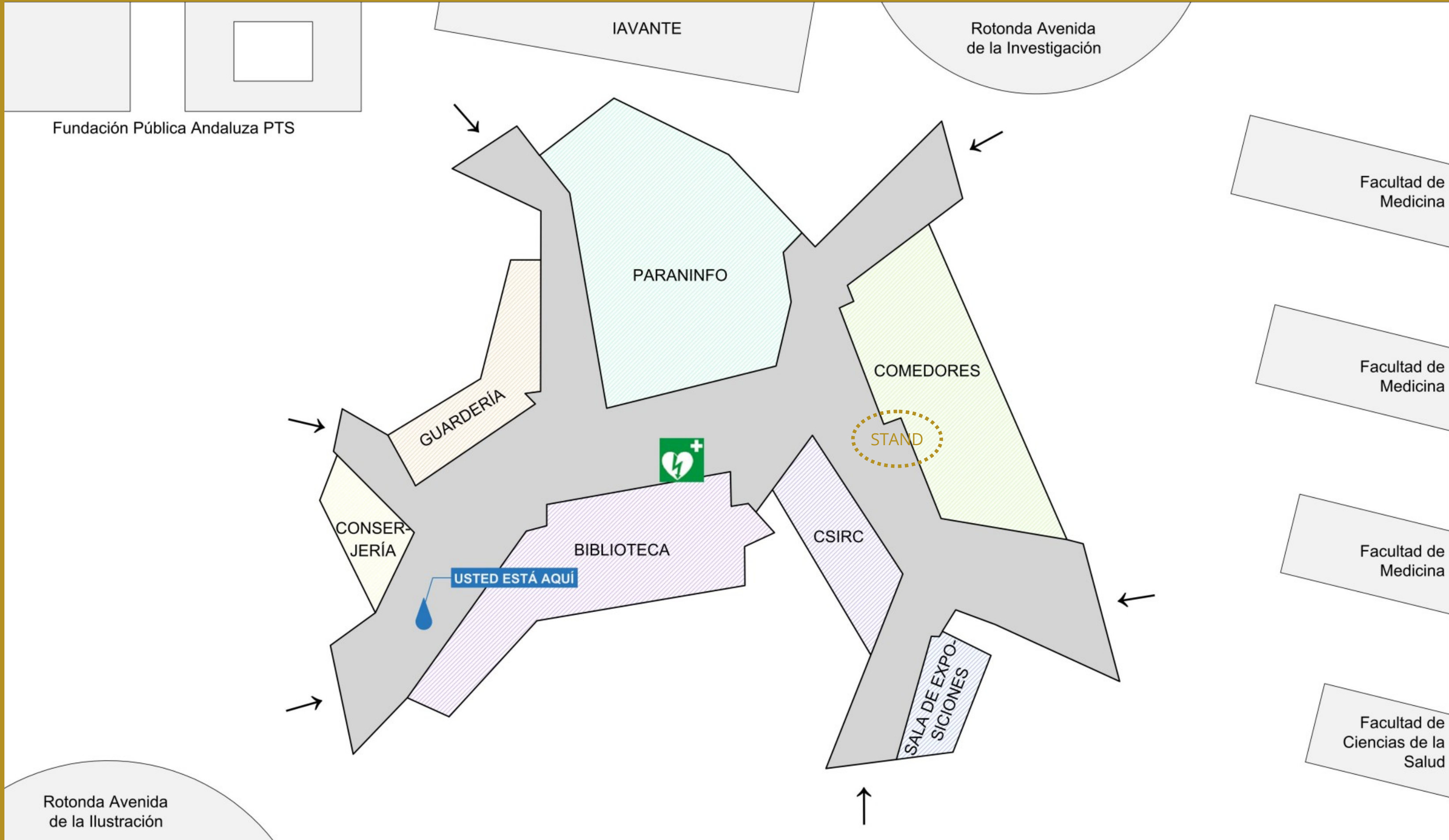

PL  
AN  
OS

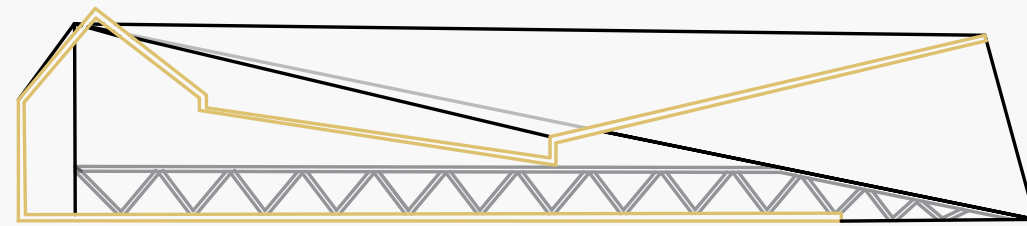

CORTE A-A'

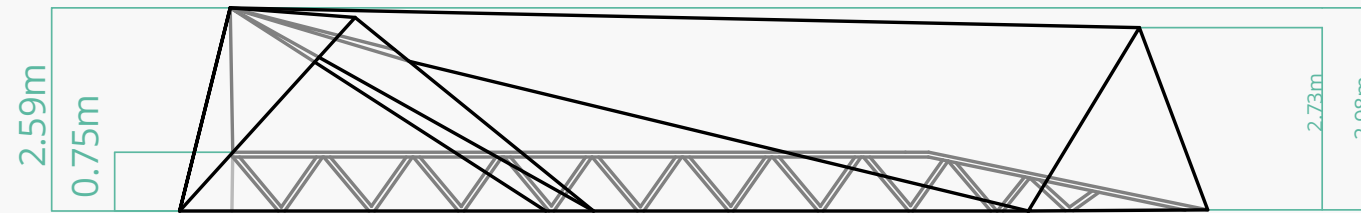

ALZADO 1

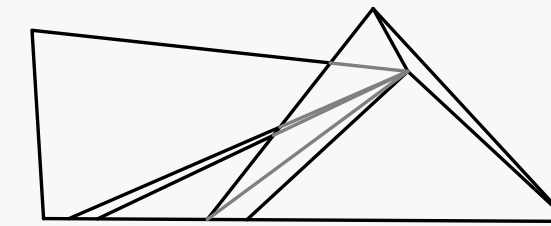

ALZADO 2

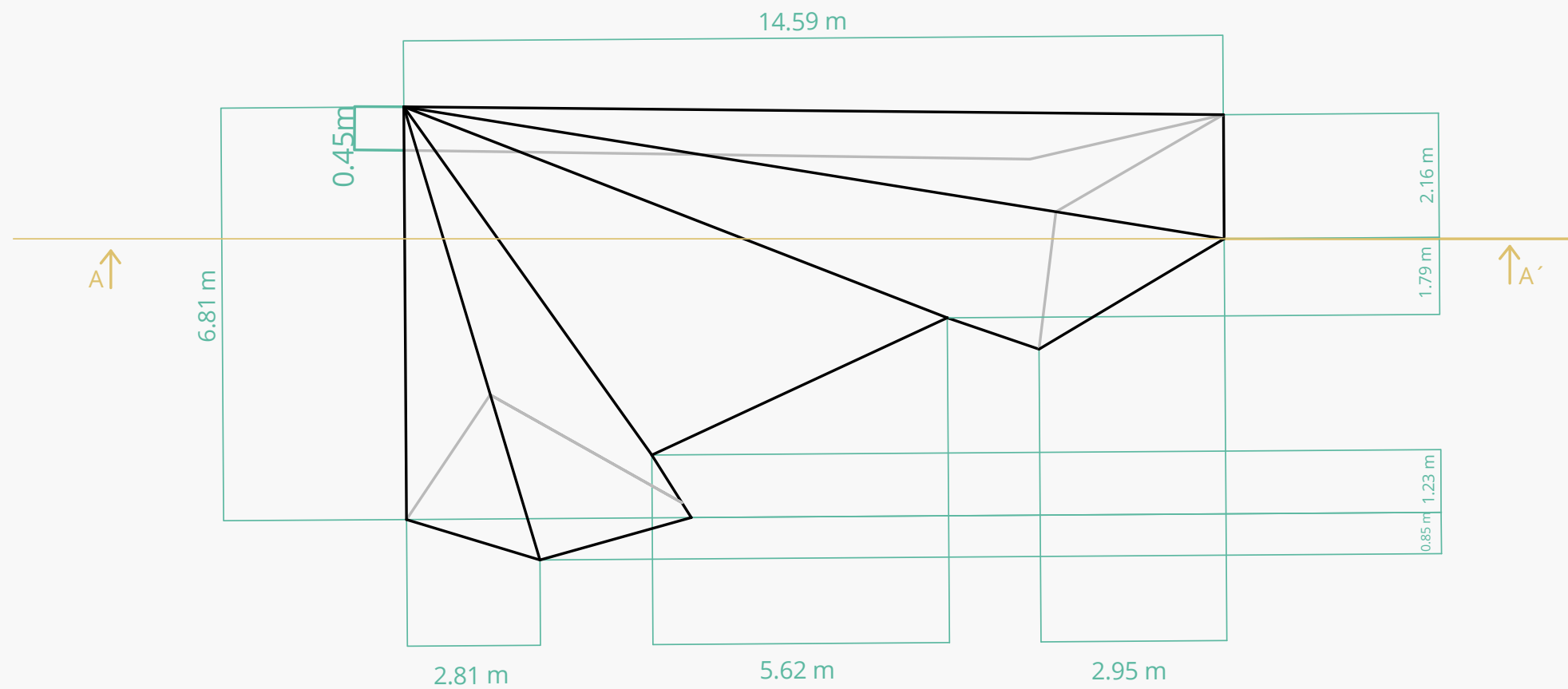

PLANTA

MA  
QUE  
TA

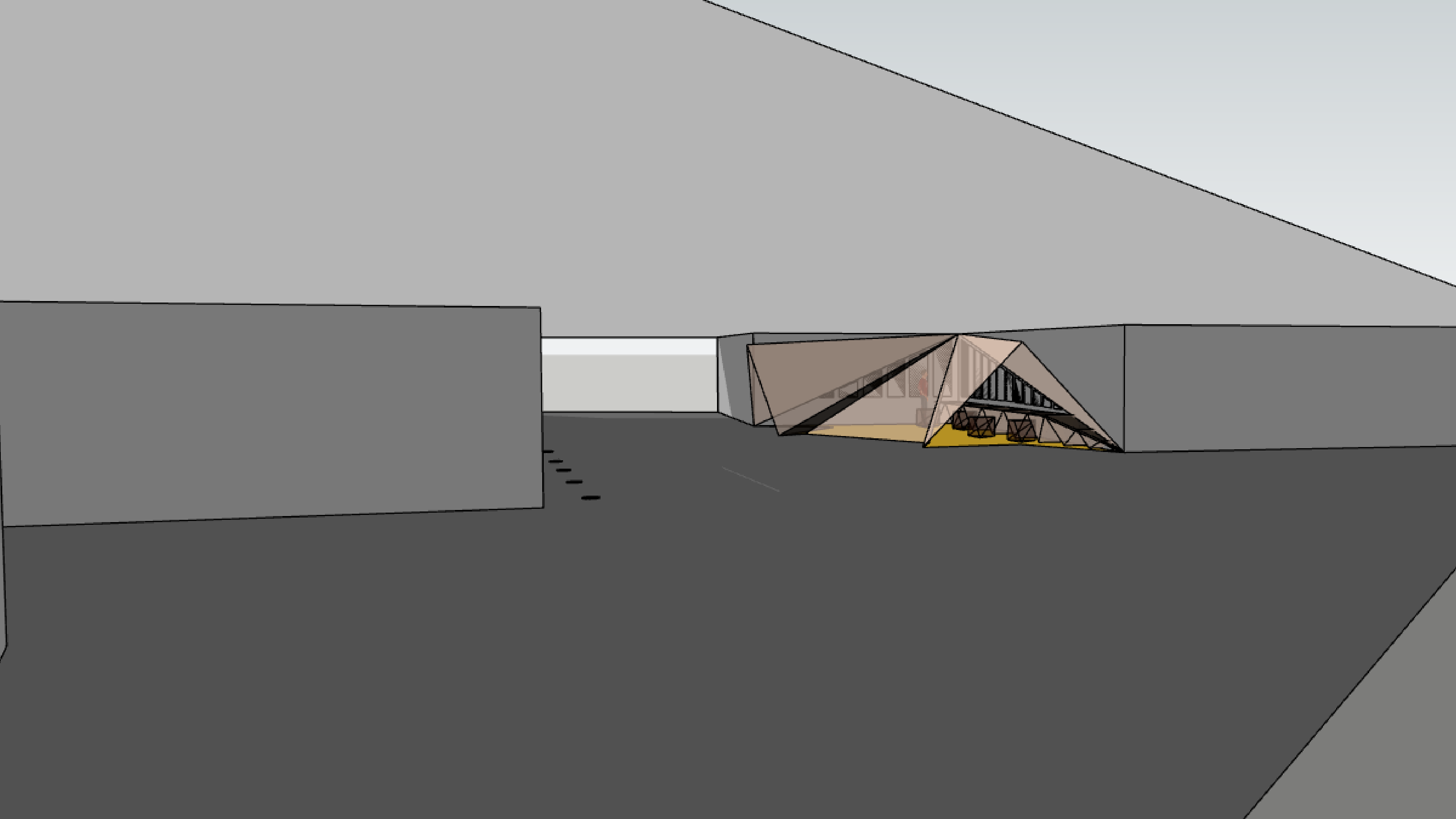

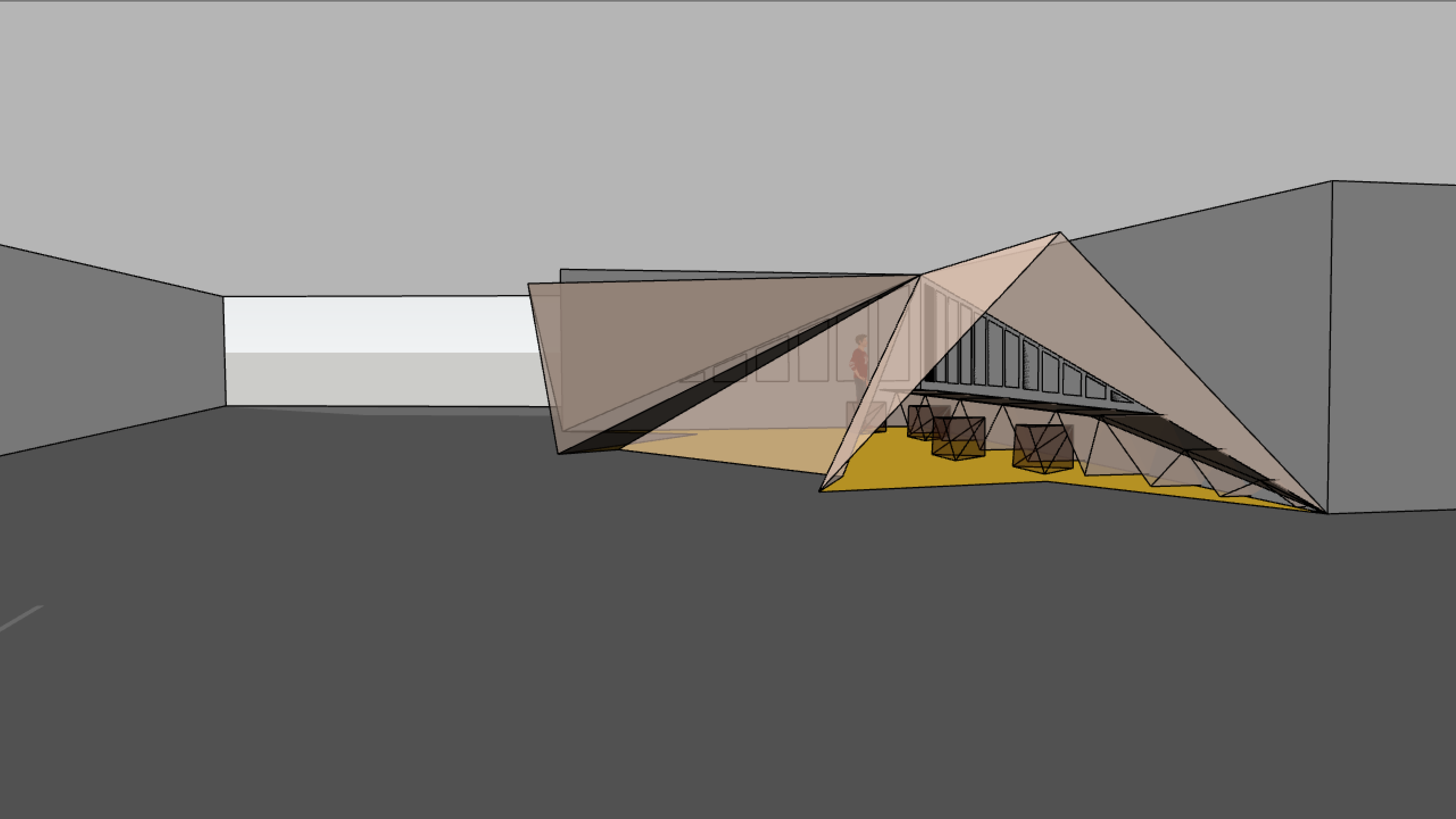



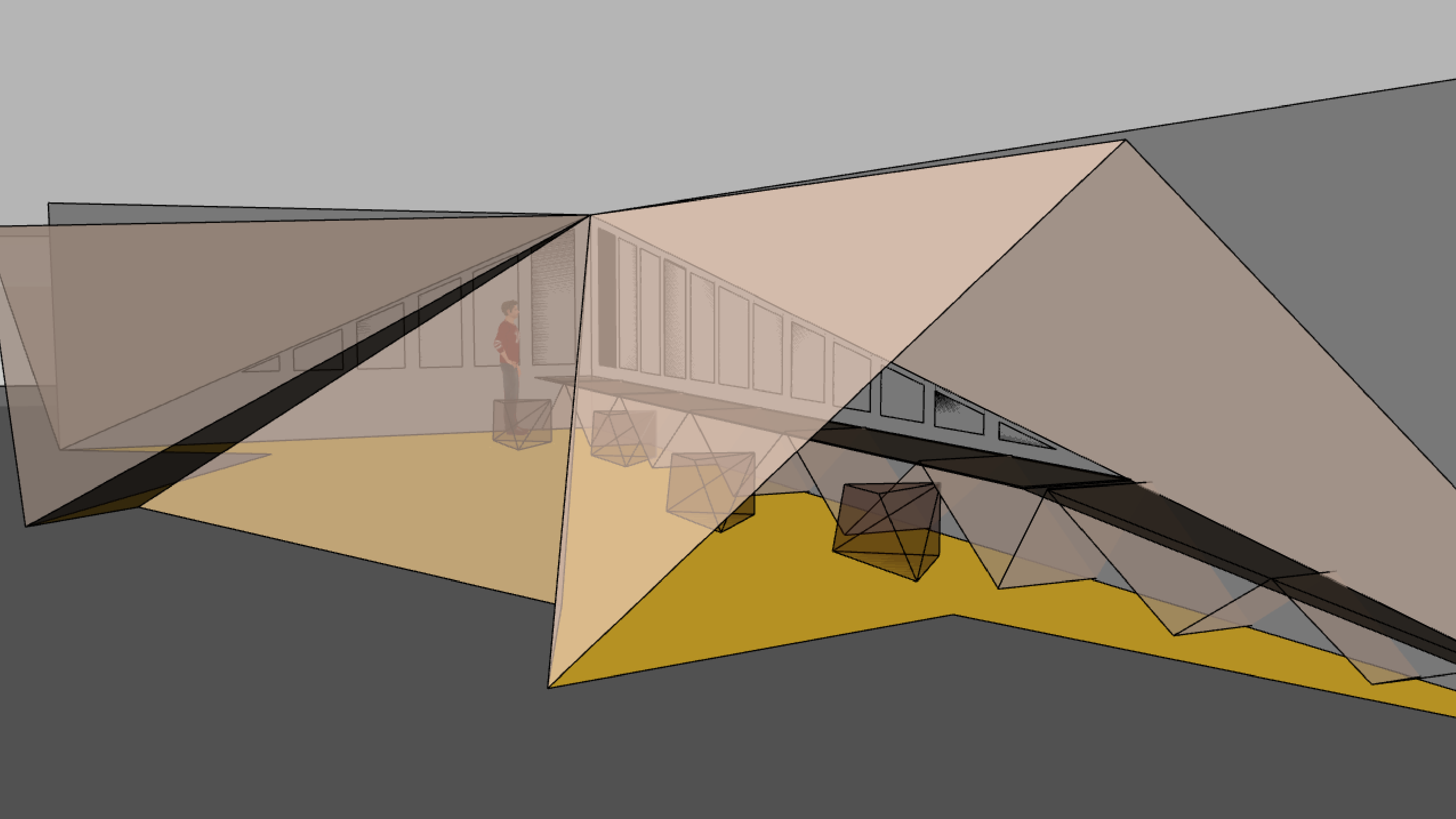

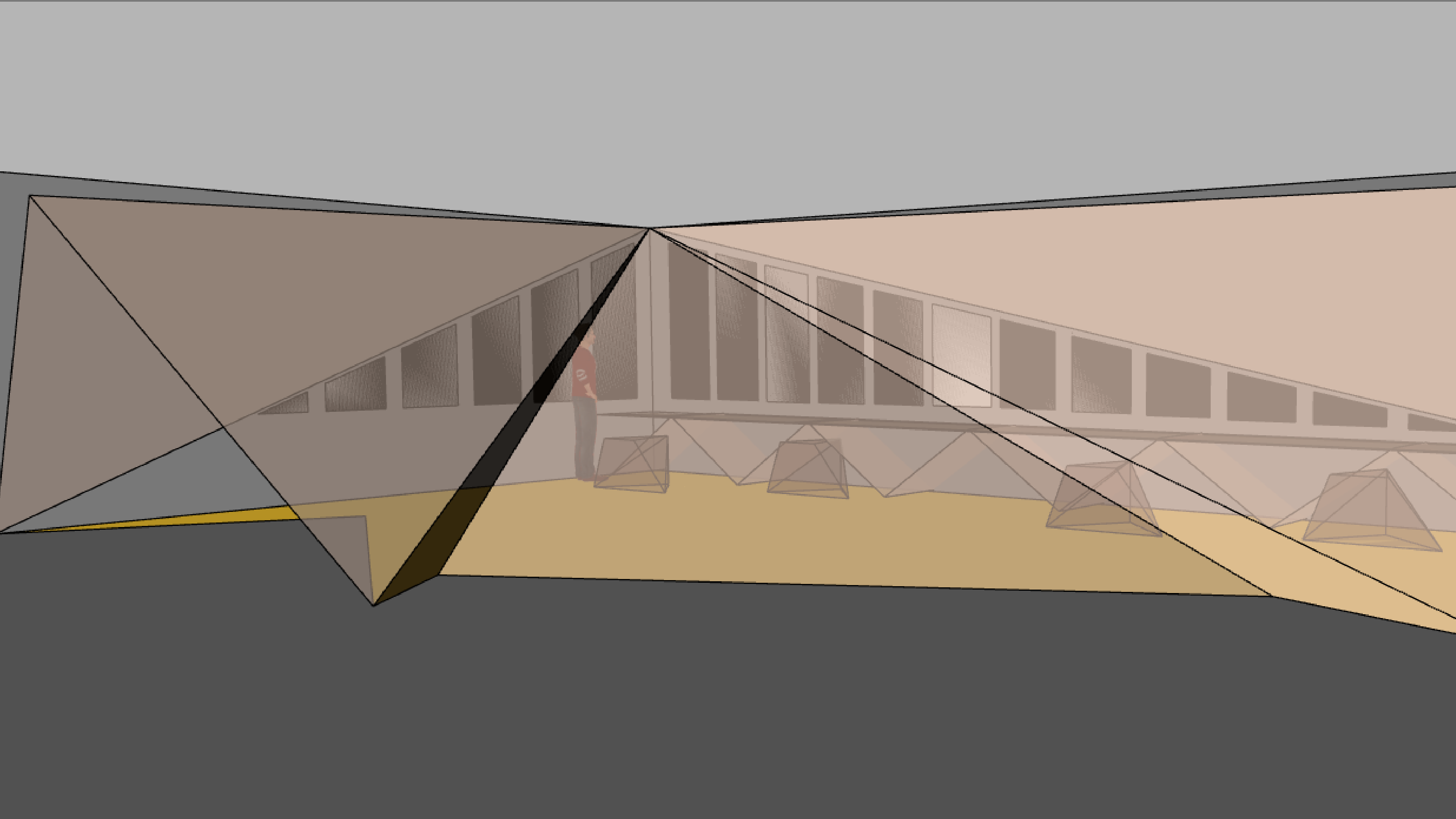

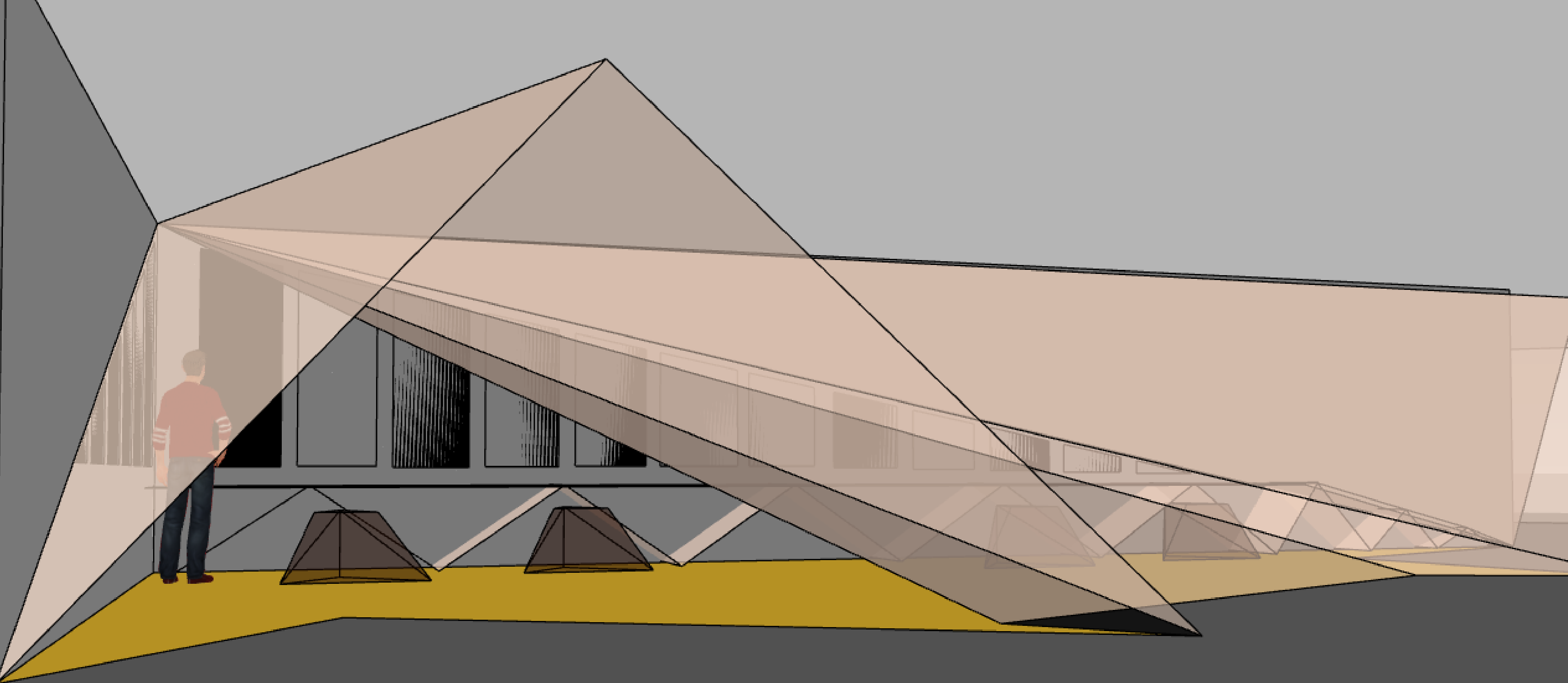

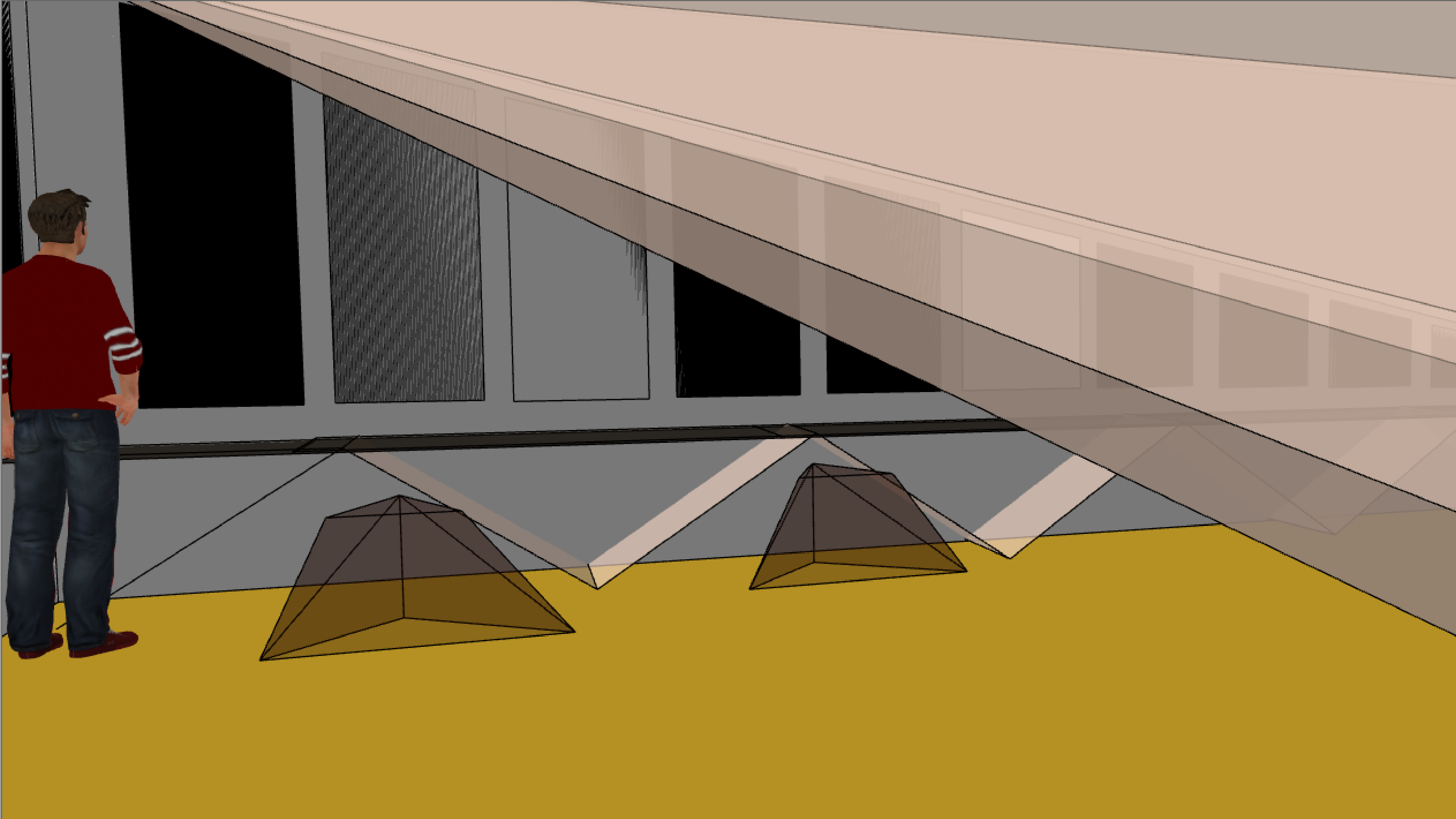

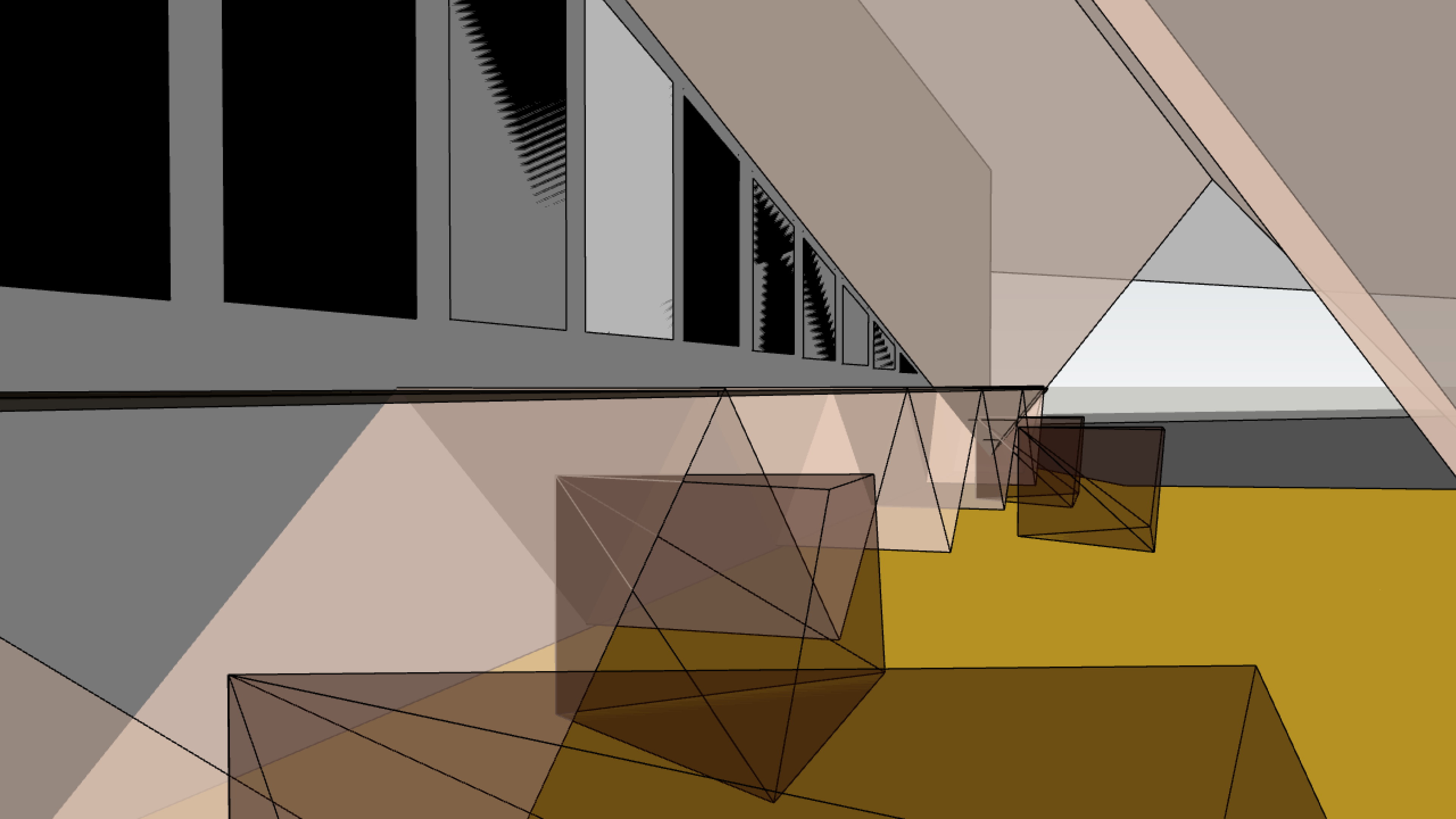

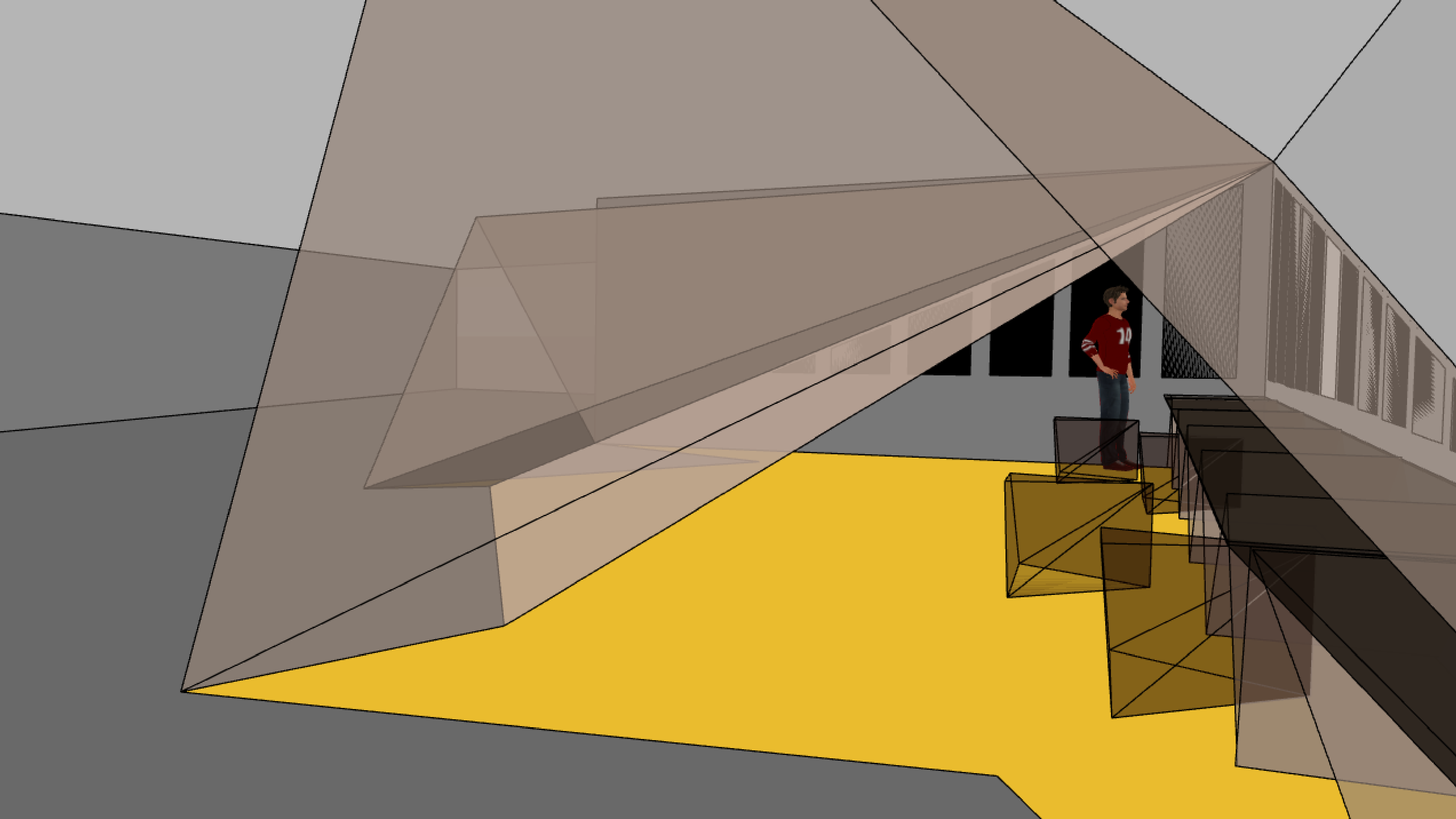

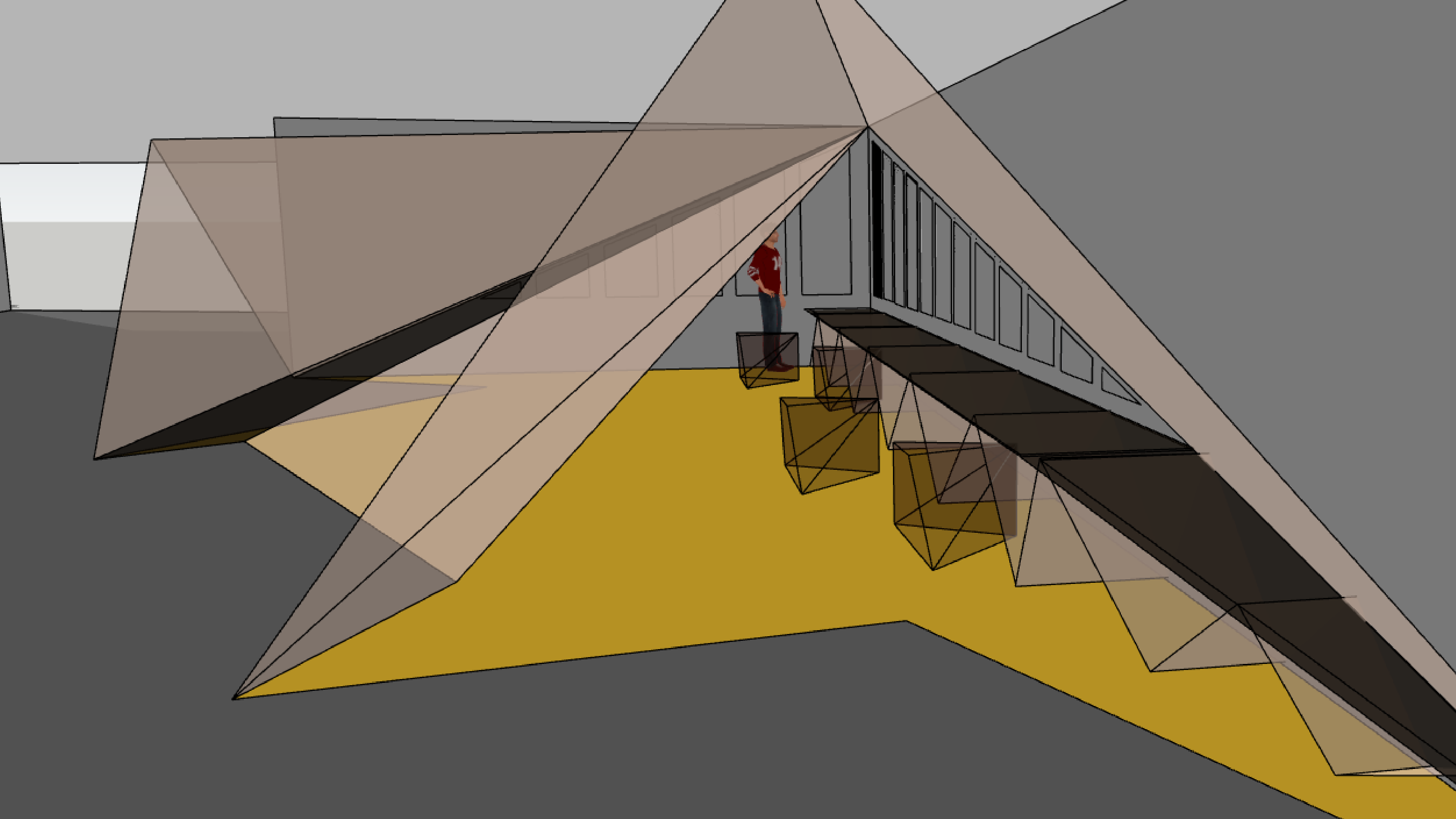

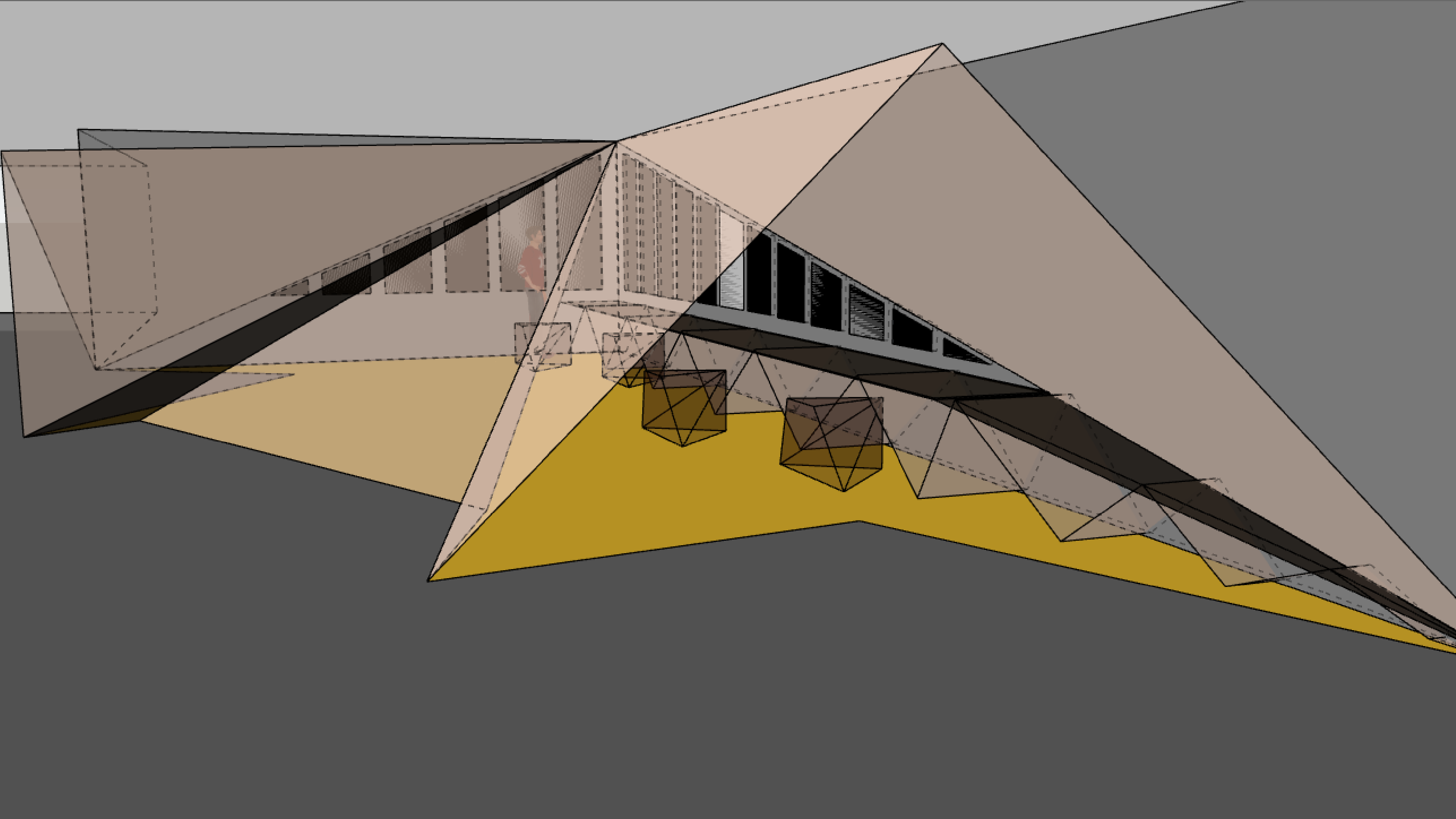



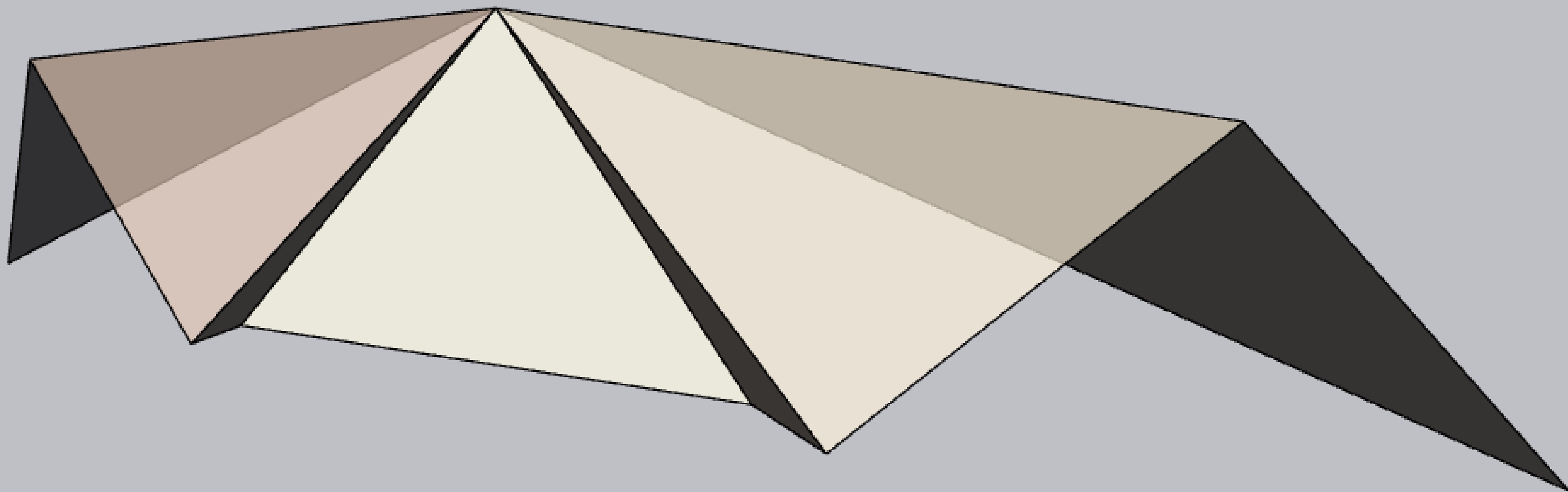

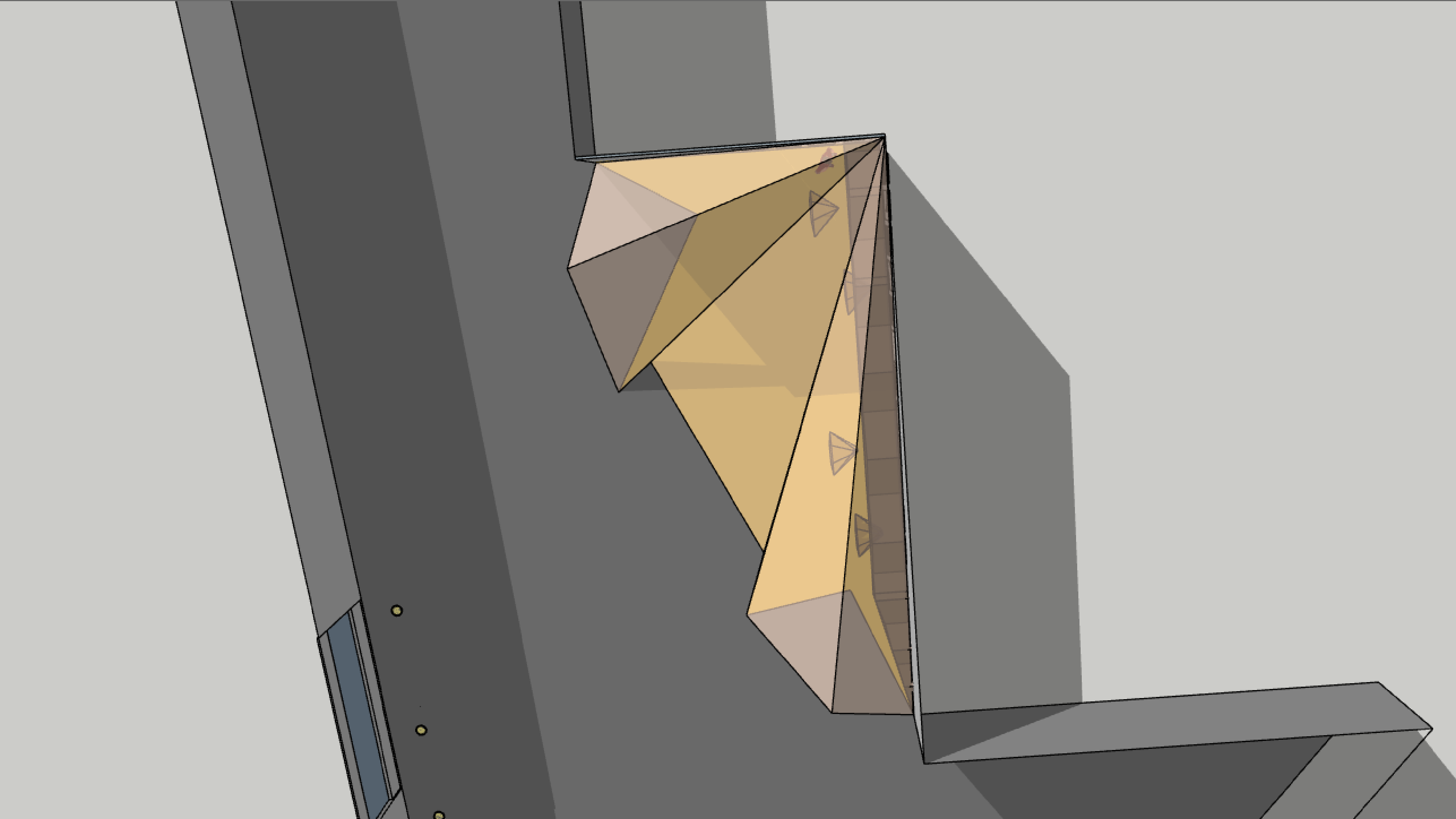

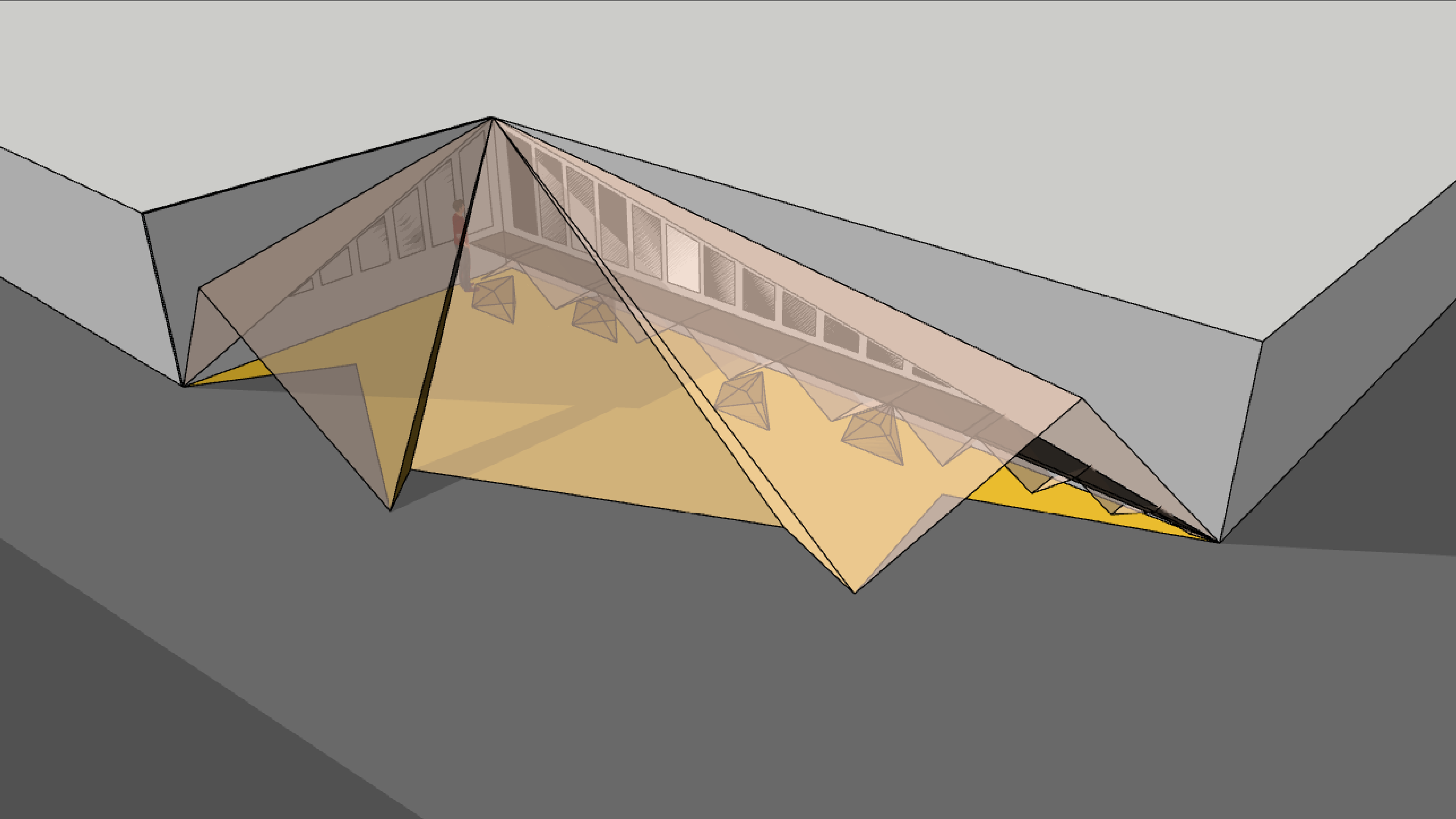

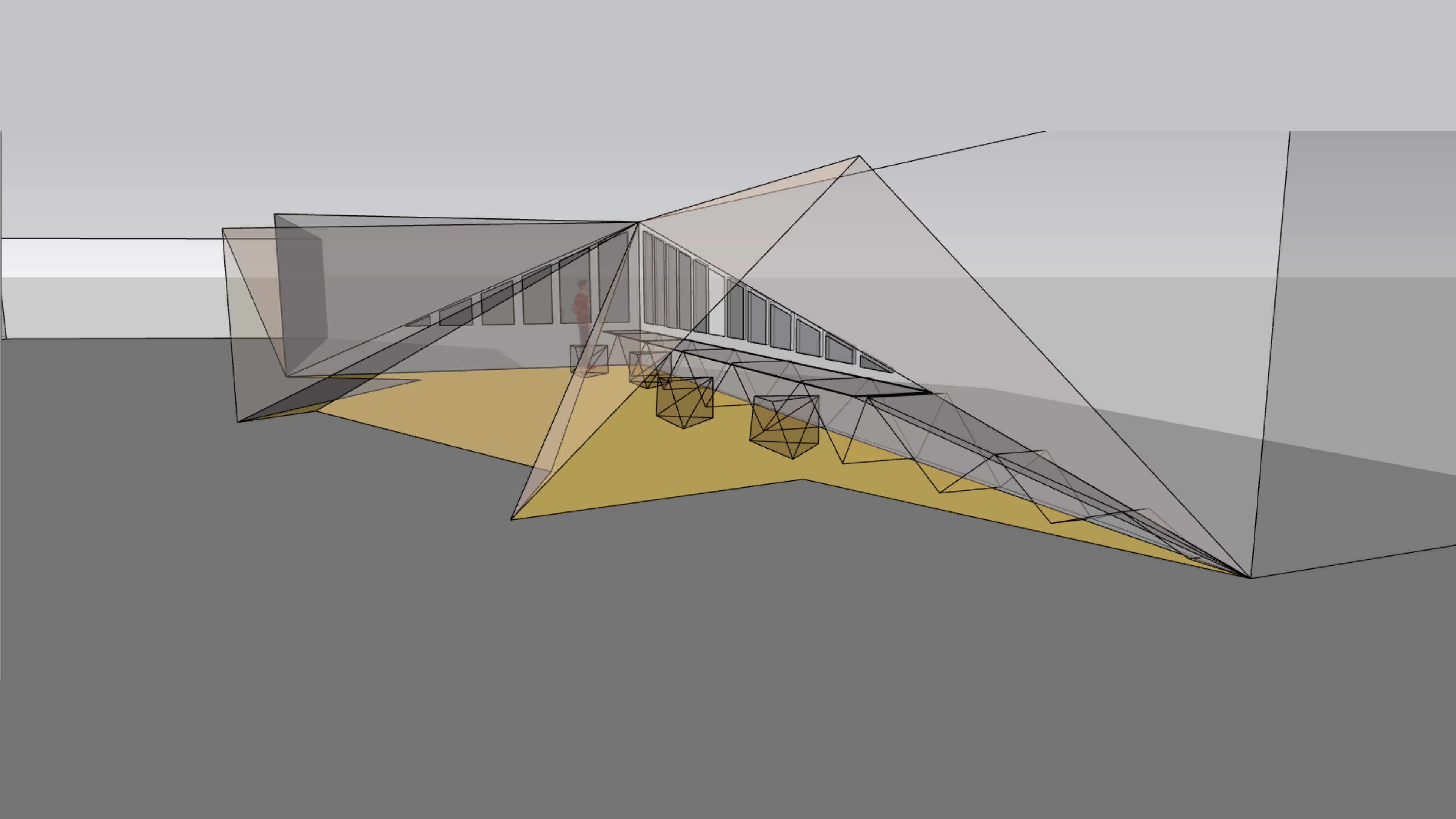

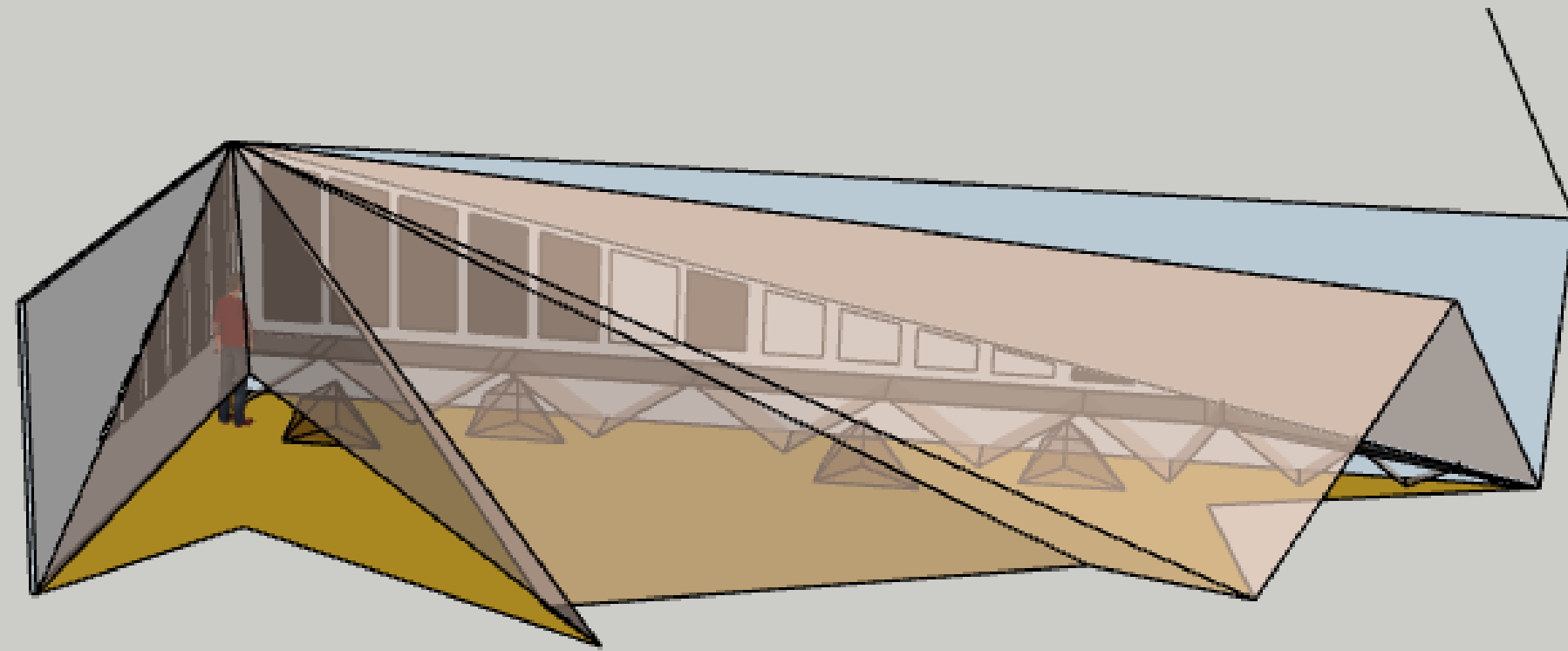

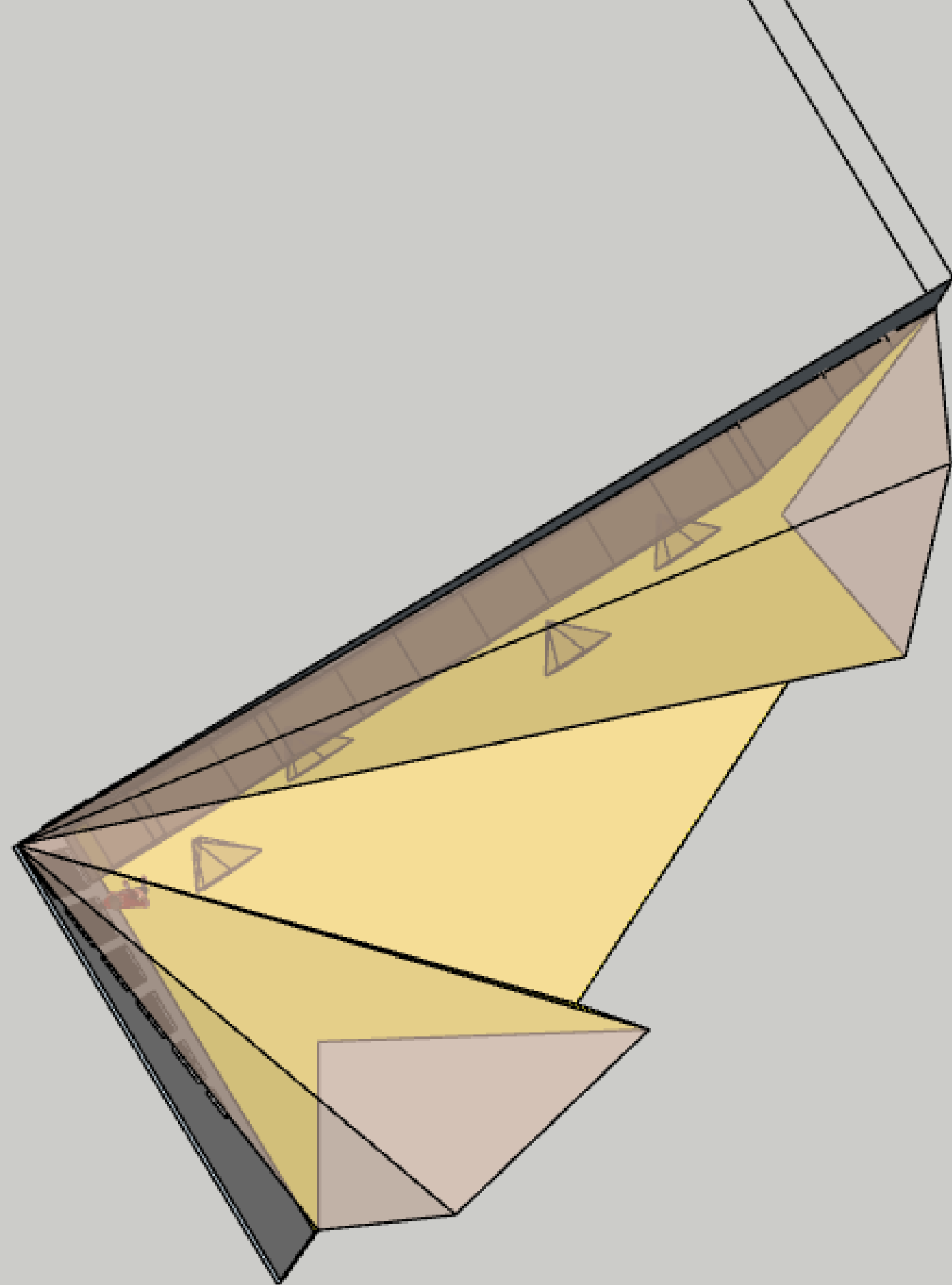



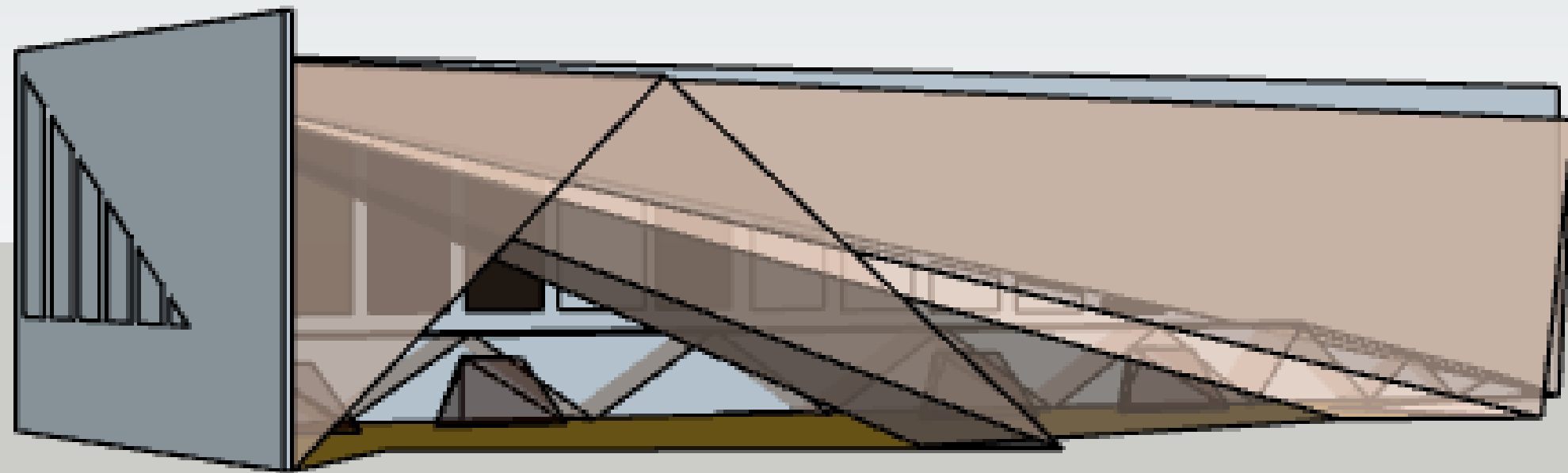



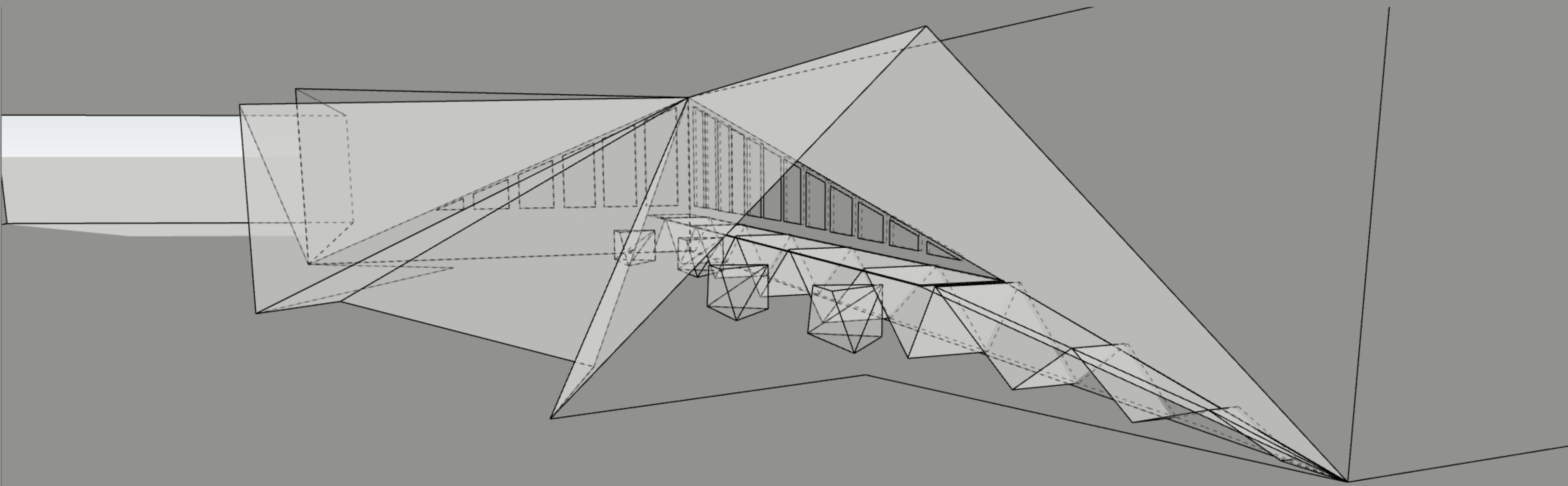

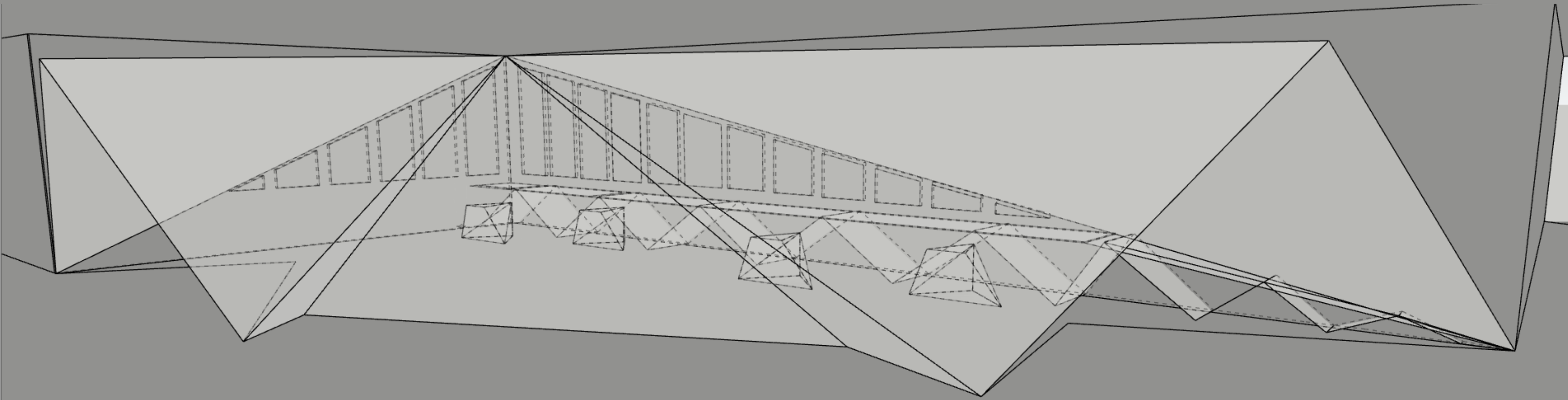

MAT  
ERIA  
LES



TELA  
TRANSLÚCIDA



TELA  
TRANSLÚCIDA



SUELO



ALUMINIO