

PLANTA, ALZADO Y SECCIONES

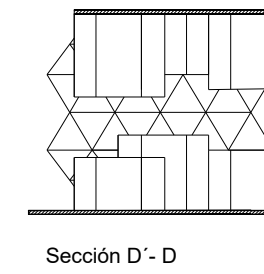
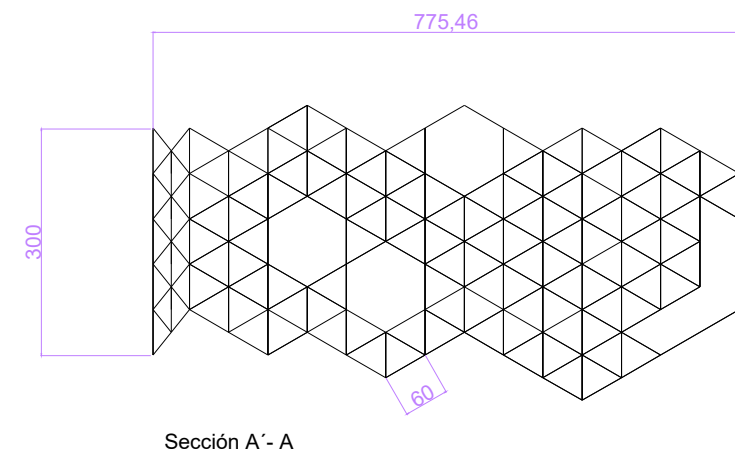
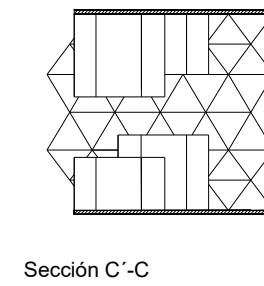
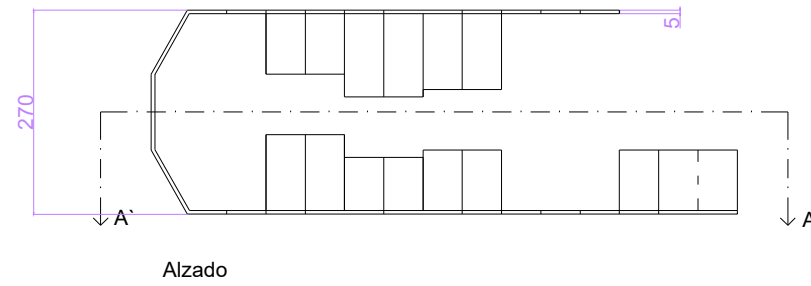
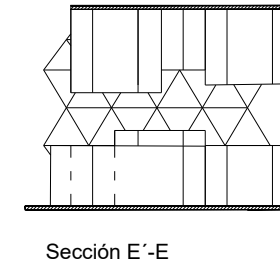
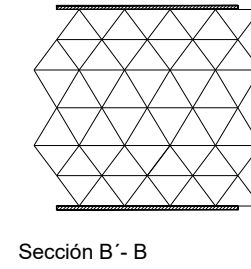
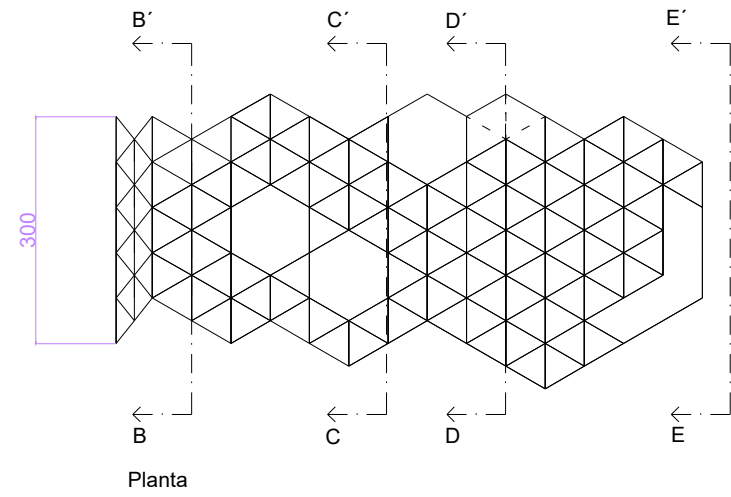

Escala gráfica
0 100 200 300 cm
E: 1:10
Lucía Mansilla Sánchez