

20/11/22 MAX PINAR PÉREZ

PLANTA E: 1/50

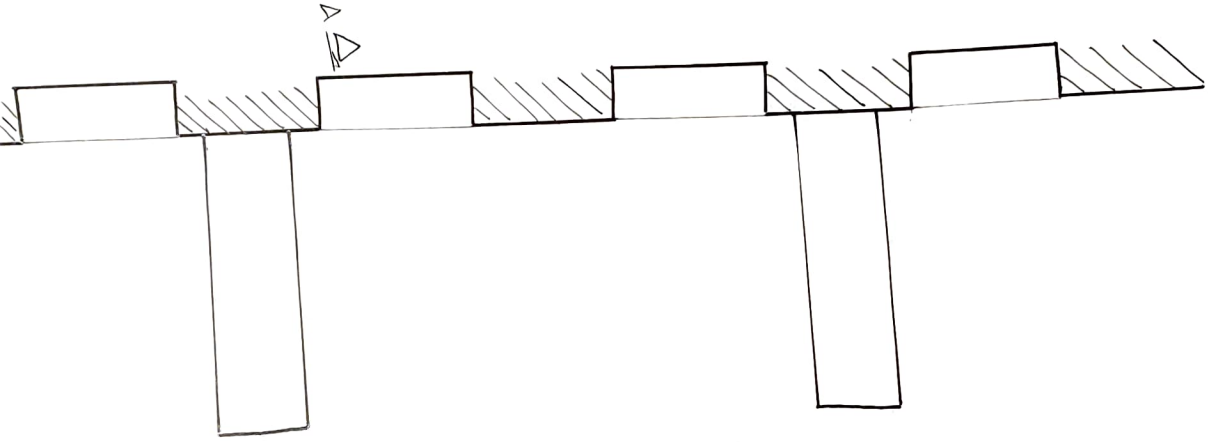

Δ 0

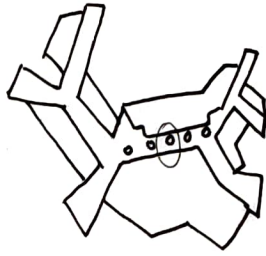
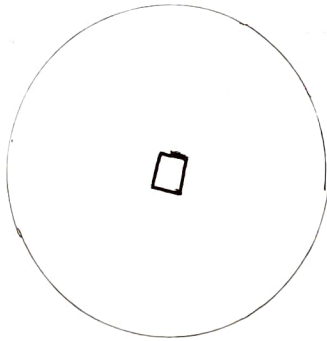

Δ B'

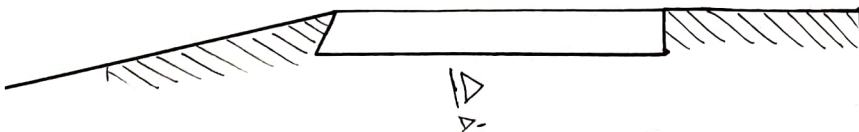

20/11/22 MAX PIÑAR PÉREZ
SECCIÓN A-A' E: 1/50

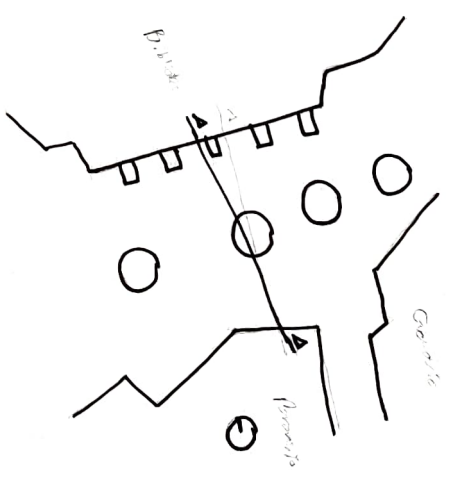
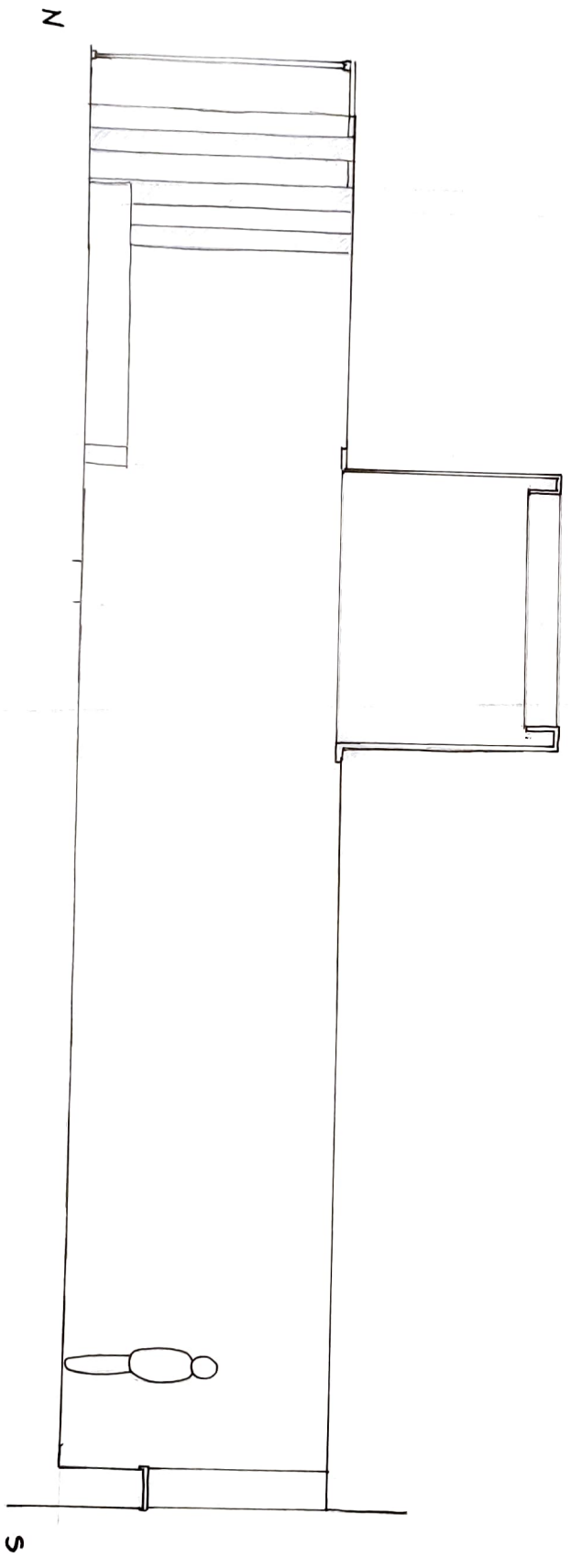

20/11/22 MAX PINAR PÉREZ
SECCIÓN B-B'

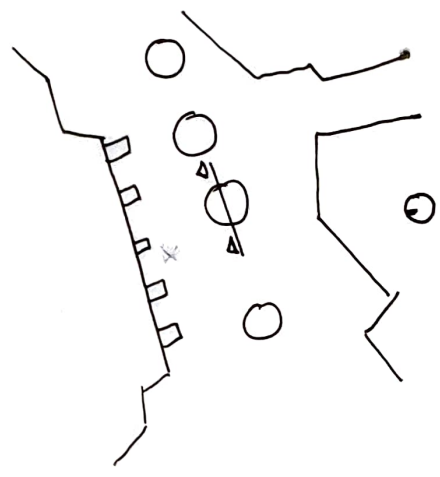

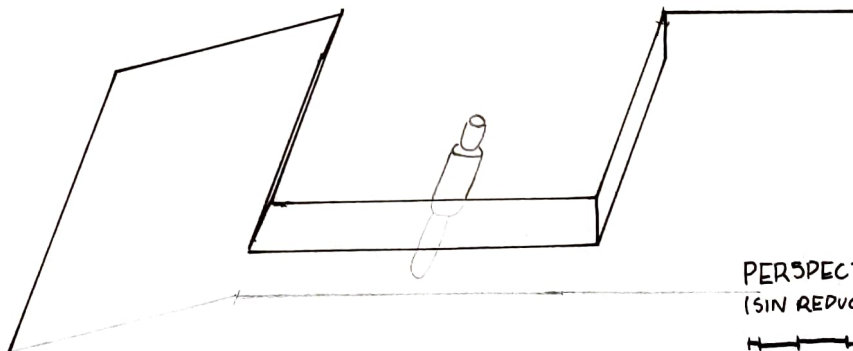
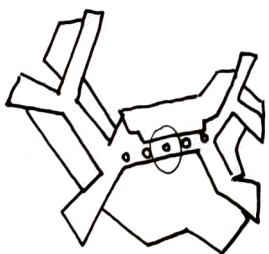
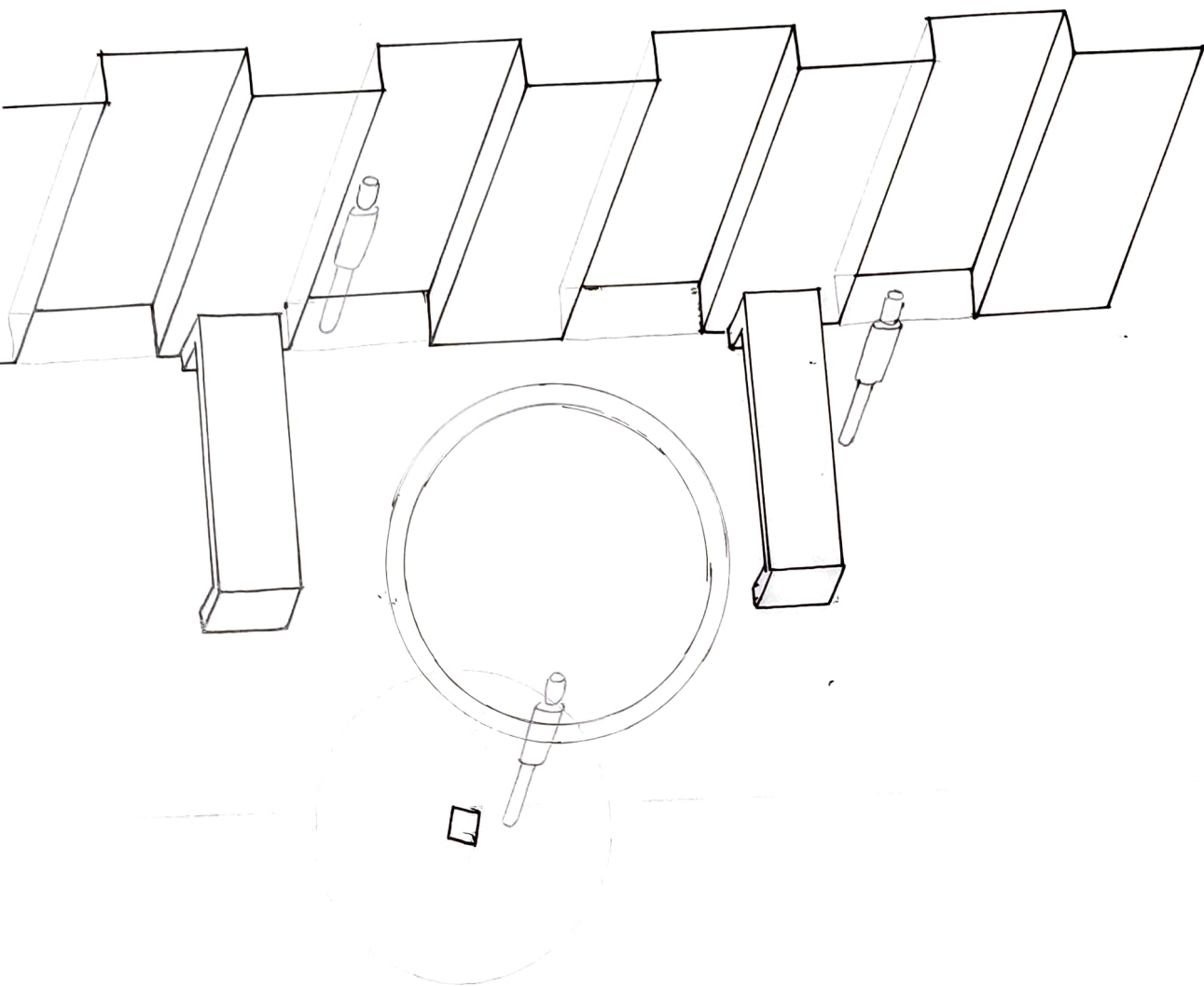

PERSPECTIVA MILITAR E:1/50
(SIN REDUCCIÓN)



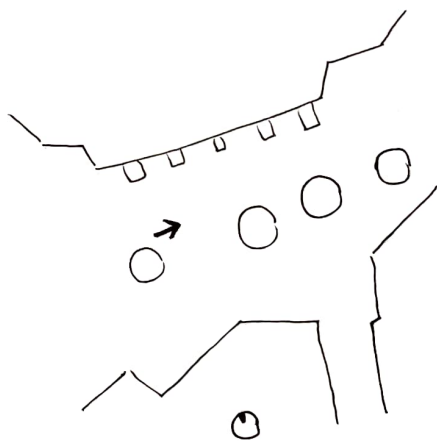
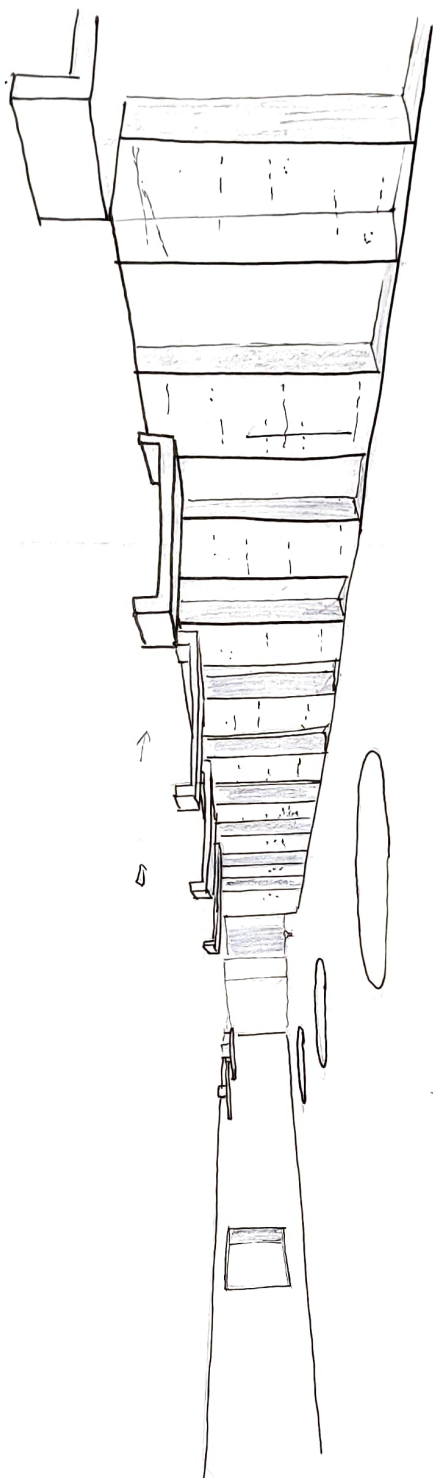

2011/1/22 MAX PIÑAR PÉREZ
PERSPECTIVA 2

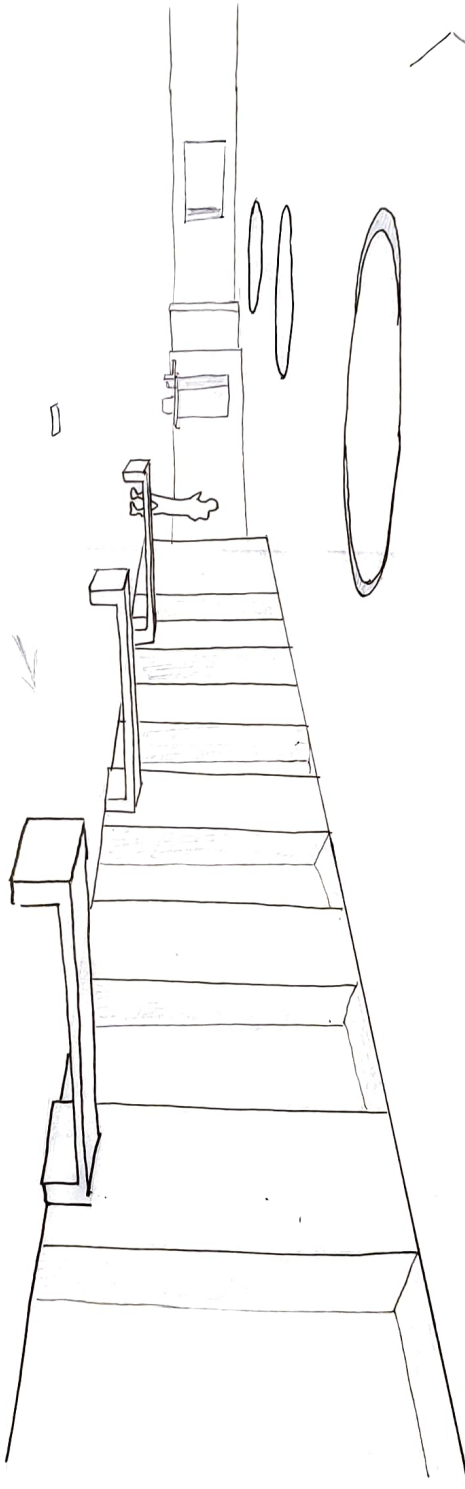
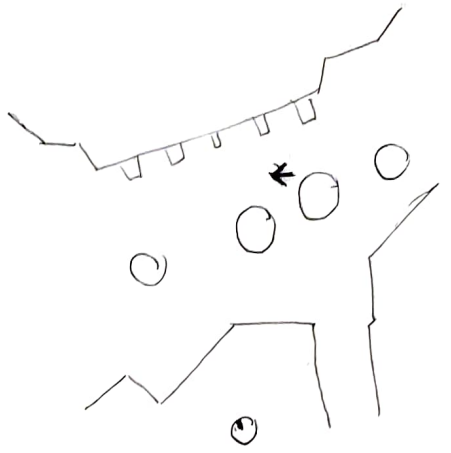

20/11/22 MAX PIÑAR PÉREZ
PERSPECTIVA 3

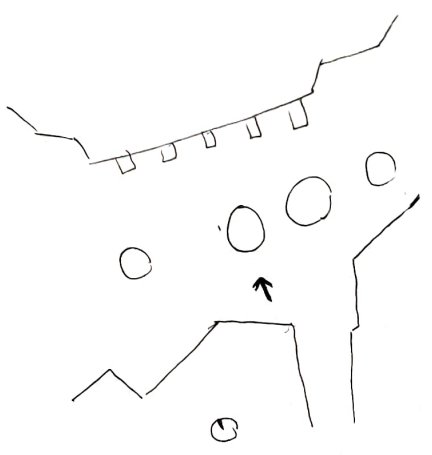
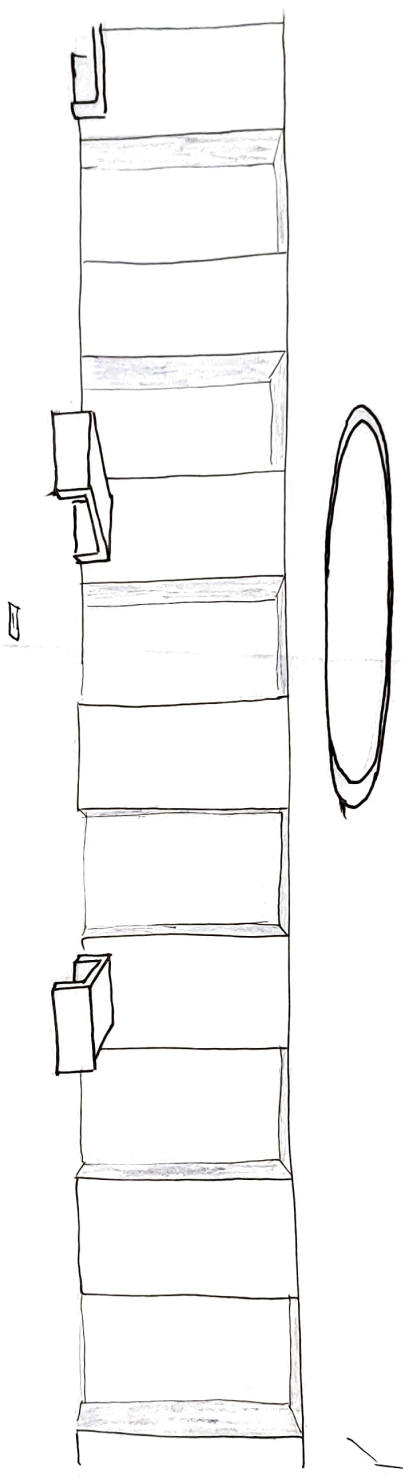

320